

DENON

DJ MIXER

DN-X100

OPERATING INSTRUCTIONS

INSTRUCCIONES DE OPERACION

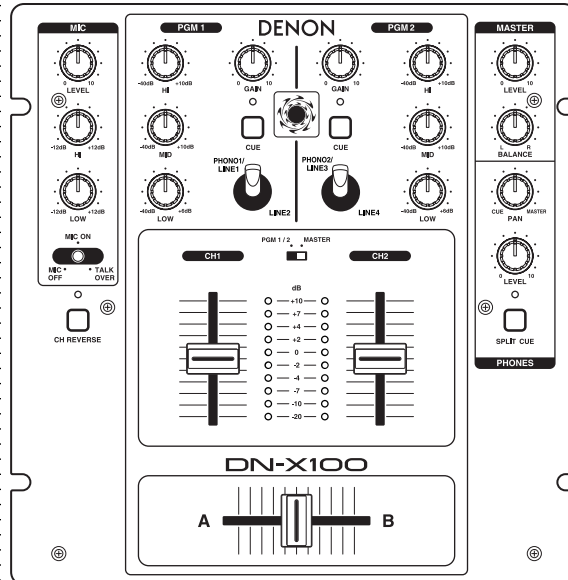

FOR ENGLISH READERS

PAGE 5 - PAGE 10

PARA LECTORES DE ESPAÑOL

PAGINA 11 - PAGINA 16



CAUTION
RISK OF ELECTRIC SHOCK
DO NOT OPEN



CAUTION: TO REDUCE THE RISK OF ELECTRIC SHOCK, DO NOT REMOVE COVER (OR BACK). NO USER SERVICEABLE PARTS INSIDE. REFER SERVICING TO QUALIFIED SERVICE PERSONNEL.



The lightning flash with arrowhead symbol, within an equilateral triangle, is intended to alert the user to the presence of uninsulated "dangerous voltage" within the product's enclosure that may be of sufficient magnitude to constitute a risk of electric shock to persons.



The exclamation point within an equilateral triangle is intended to alert the user to the presence of important operating and maintenance (servicing) instructions in the literature accompanying the appliance.

WARNING: TO PREVENT FIRE OR SHOCK HAZARD, DO NOT EXPOSE THIS APPLIANCE TO RAIN OR MOISTURE.

CAUTION:

1. Handle the power supply cord carefully

Do not damage or deform the power supply cord. If it is damaged or deformed, it may cause electric shock or malfunction when used. When removing from wall outlet, be sure to remove by holding the plug attachment and not by pulling the cord.

2. Do not open the top cover

In order to prevent electric shock, do not open the top cover. If problems occur, contact your DENON dealer.

3. Do not place anything inside

Do not place metal objects or spill liquid inside the DJ mixer. Electric shock or malfunction may result.

Please, record and retain the Model name and serial number of your set shown on the rating label.

Model No. DN-X100 Serial No. _____

LABELS:

CAUTION
TO PREVENT ELECTRIC SHOCK, MATCH WIDE BLADE OF PLUG TO WIDE SLOT, FULLY INSERT.

ATTENTION
POUR ÉVITER LES CHOCS ÉLECTRIQUES, INTERDUIRE LA LAME LA PLUS LARGE DE LA FICHE DANS LA BORNE CORRESPONDANTE DE LA PRISE ET POUSSER JUSQU' AU FOND.

SAFETY INSTRUCTIONS

- Read Instructions – All the safety and operating instructions should be read before the product is operated.
- Retain Instructions – The safety and operating instructions should be retained for future reference.
- Heed Warnings – All warnings on the product and in the operating instructions should be adhered to.
- Follow Instructions – All operating and use instructions should be followed.
- Cleaning – Unplug this product from the wall outlet before cleaning. Do not use liquid cleaners or aerosol cleaners.
- Attachments – Do not use attachments not recommended by the product manufacturer as they may cause hazards.
- Water and Moisture – Do not use this product near water – for example, near a bath tub, wash bowl, kitchen sink, or laundry tub; in a wet basement; or near a swimming pool; and the like.
- Accessories – Do not place this product on an unstable cart, stand, tripod, bracket, or table. The product may fall, causing serious injury to a child or adult, and serious damage to the product. Use only with a cart, stand, tripod, bracket, or table recommended by the manufacturer, or sold with the product. Any mounting of the product should follow the manufacturer's instructions, and should use a mounting accessory recommended by the manufacturer.
- A product and cart combination should be moved with care. Quick stops, excessive force, and uneven surfaces may cause the product and cart combination to overturn.
- Ventilation – Slots and openings in the cabinet are provided for ventilation and to ensure reliable operation of the product and to protect it from overheating, and these openings must not be blocked or covered. The openings should never be blocked by placing the product on a bed, sofa, rug, or other similar surface. This product should not be placed in a built-in installation such as a bookcase or rack unless proper ventilation is provided or the manufacturer's instructions have been adhered to.
- Power Sources – This product should be operated only from the type of power source indicated on the marking label. If you are not sure of the type of power supply to your home, consult your product dealer or local power company. For products intended to operate from battery power, or other sources, refer to the operating instructions.
- Grounding or Polarization – This product may be equipped with a polarized alternating-current line plug (a plug having one blade wider than the other). This plug will fit into the power outlet only one way. This is a safety feature. If you are unable to insert the plug fully into the outlet, try reversing the plug. If the plug should still fail to fit, contact your electrician to replace your obsolete outlet. Do not defeat the safety purpose of the polarized plug.
- Power-Cord Protection – Power-supply cords should be routed so that they are not likely to be walked on or pinched by items placed upon or against them, paying particular attention to cords at plugs, convenience receptacles, and the point where they exit from the product.
- Outdoor Antenna Grounding – If an outside antenna or cable system is connected to the product, be sure the antenna or cable system is grounded so as to provide some protection against voltage surges and built-up static charges. Article 810 of the National Electrical Code, ANSI/NFPA 70, provides information with regard to proper grounding of the mast and supporting structure, grounding of the lead-in wire to an antenna discharge unit, size of grounding conductors, location of antenna-discharge unit, connection to grounding electrodes, and requirements for the grounding electrode. See Figure A.
- Lightning – For added protection for this product during a lightning storm, or when it is left unattended and unused for long periods of time, unplug it from the wall outlet and disconnect the antenna or cable system. This will prevent damage to the product due to lightning and power-line surges.
- Power Lines – An outside antenna system should not be located in the vicinity of overhead power lines or other electric light or power circuits, or where it can fall into such power lines or circuits. When installing an outside antenna system, extreme care should be taken to keep from touching such power lines or circuits as contact with them might be fatal.
- Overloading – Do not overload wall outlets, extension cords, or integral convenience receptacles as this can result in a risk of fire or electric shock.
- Object and Liquid Entry – Never push objects of any kind into this product through openings as they may touch dangerous voltage points or short-out parts that could result in a fire or electric shock. Never spill liquid of any kind on the product.
- Servicing – Do not attempt to service this product yourself as opening or removing covers may expose you to dangerous voltage or other hazards. Refer all servicing to qualified service personnel.
- Damage Requiring Service – Unplug this product from the wall outlet and refer servicing to qualified service personnel under the following conditions:
 - When the power-supply cord or plug is damaged,
 - If liquid has been spilled, or objects have fallen into the product,
 - If the product has been exposed to rain or water,
 - If the product does not operate normally by following the operating instructions. Adjust only those controls that are covered by the operating instructions as an improper adjustment of other controls may result in damage and will often require extensive work by a qualified technician to restore the product to its normal operation,
 - If the product has been dropped or damaged in any way, and
 - When the product exhibits a distinct change in performance – this indicates a need for service.
- Replacement Parts – When replacement parts are required, be sure the service technician has used replacement parts specified by the manufacturer or have the same characteristics as the original part. Unauthorized substitutions may result in fire, electric shock, or other hazards.
- Safety Check – Upon completion of any service or repairs to this product, ask the service technician to perform safety checks to determine that the product is in proper operating condition.
- Wall or Ceiling Mounting – The product should be mounted to a wall or ceiling only as recommended by the manufacturer.
- Heat – The product should be situated away from heat sources such as radiators, heat registers, stoves, or other products (including amplifiers) that produce heat.

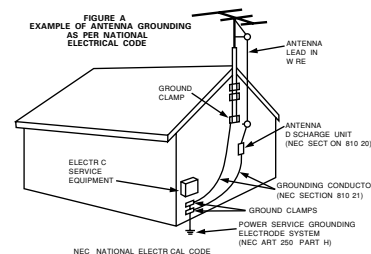

TOP PANEL DIAGRAM / DIAGRAMA DEL PANEL SUPERIOR

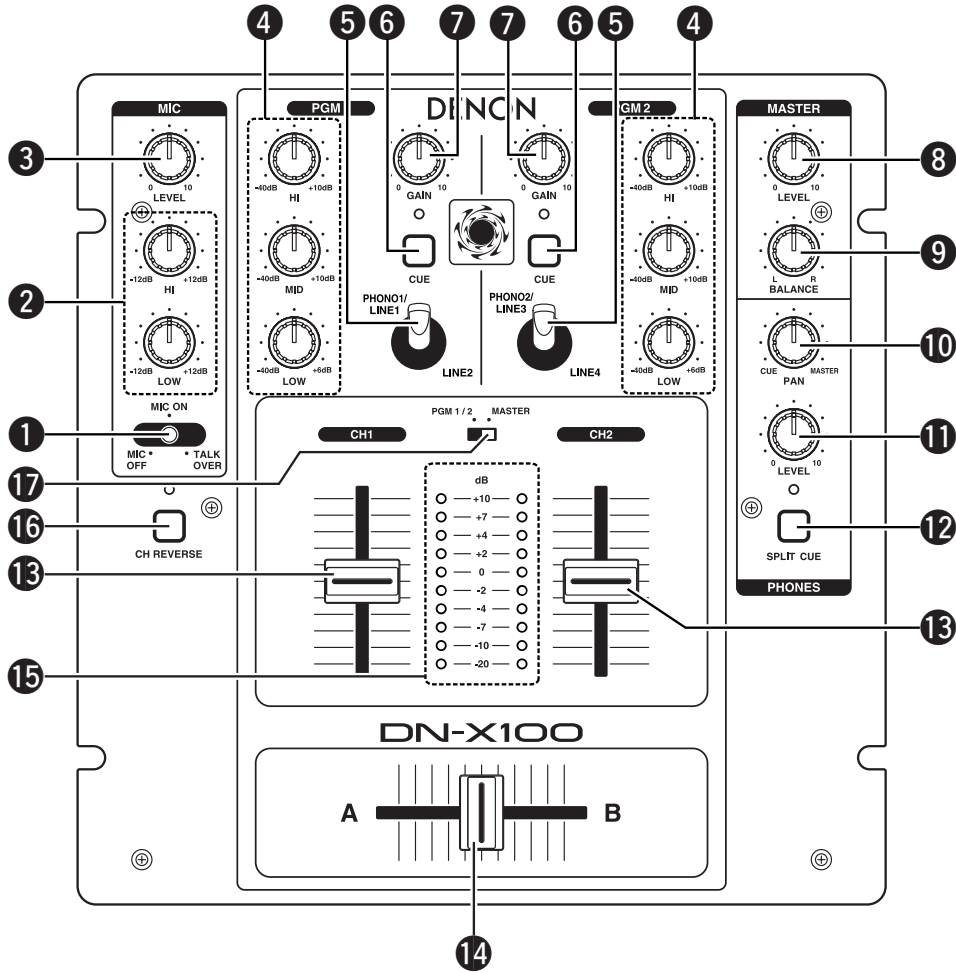

REAR PANEL DIAGRAM / DIAGRAMA DEL PANEL POSTERIOR

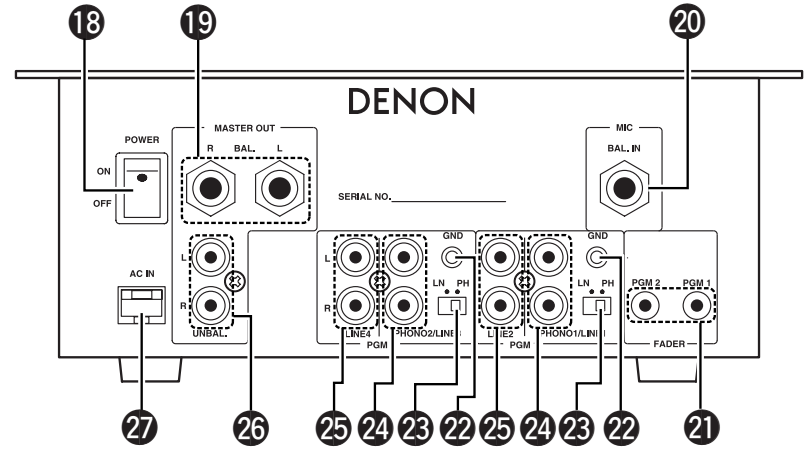

FRONT PANEL DIAGRAM / DIAGRAMA DEL PANEL FRONTAL

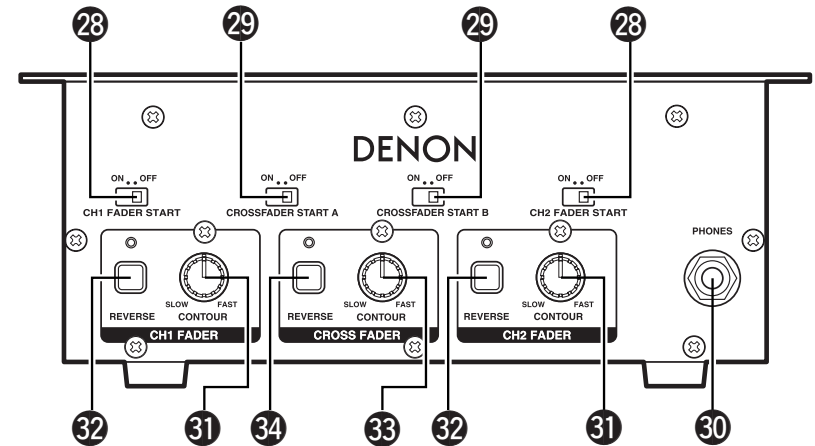

**NOTE ON USE / HINWEISE ZUM GEBRAUCH /
OBSERVATIONS RELATIVES A L'UTILISATION / NOTE SULL'USO
NOTAS SOBRE EL USO / ALVORENS TE GEBRUIKEN / OBSERVERA**

 <ul style="list-style-type: none"> • Avoid high temperatures. Allow for sufficient heat dispersion when installed on a rack. • Vermeiden Sie hohe Temperaturen. Beachten Sie, daß eine ausreichend Luftzirkulation gewährleistet wird, wenn das Gerät auf ein Regal gestellt wird. • Éviter des températures élevées. Tenir compte d'une dispersion de chaleur suffisante lors de l'installation sur une étagère. • Evitate di esporre l'unità a temperature alte. Assicuratevi che ci sia un'adeguata dispersione del calore quando installate l'unità in un mobile per componenti audio. • Evite altas temperaturas. Permita la suficiente dispersión del calor cuando está instalado en la consola. • Vermijd hoge temperaturen. Zorg voor een degelijk hitteafvoer indien het apparaat op een rek wordt geplaatst. • Undvik höga temperaturer. Se till att det finns möjlighet till god värmeavledning vid montering i ett rack. 	 <ul style="list-style-type: none"> • Keep the set free from moisture, water, and dust. • Halten Sie das Gerät von Feuchtigkeit, Wasser und Staub fern. • Protéger l'appareil contre l'humidité, l'eau et la poussière. • Tenete l'unità lontana dall'umidità, dall'acqua e dalla polvere. • Mantenga el equipo libre de humedad, agua y polvo. • Laat geen vochtigheid, water of stof in het apparaat binnendringen. • Utsätt inte apparaten för fukt, vatten och damm. 	 <ul style="list-style-type: none"> • Do not let foreign objects in the set. • Keine fremden Gegenstände in das Gerät kommen lassen. • Ne pas laisser des objets étrangers dans l'appareil. • E' importante che nessun oggetto è inserito all'interno dell'unità. • No deje objetos extraños dentro del equipo. • Laat geen vreemde voorwerpen in dit apparaat vallen. • Se till att främmande föremål inte tränger in i apparaten.
 <ul style="list-style-type: none"> • Handle the power cord carefully. Hold the plug when unplugging the cord. • Gehen Sie vorsichtig mit dem Netzkabel um. Halten Sie das Kabel am Stecker, wenn Sie den Stecker herausziehen. • Manipuler le cordon d'alimentation avec précaution. Tenir la prise lors du débranchement du cordon. • Maneggiare il filo di alimentazione con cura. Agitare per la spina quando scollegate il cavo dalla presa. • Maneje el cordón de energía con cuidado. Sostenga el enchufe cuando desconecte el cordón de energía. • Hanteer het netsnoer voorzichtig. Houd het snoer bij de stekker vast wanneer deze moet worden aan- of losgekoppeld. • Hantera nätkablen varsamt. Håll i kabeln när den kopplas från el-uttaget. 	 <ul style="list-style-type: none"> • Unplug the power cord when not using the set for long periods of time. • Wenn das Gerät eine längere Zeit nicht verwendet werden soll, trennen Sie das Netzkabel vom Netzstecker. • Débrancher le cordon d'alimentation lorsque l'appareil n'est pas utilisé pendant de longues périodes. • Disinnestate il filo di alimentazione quando avete l'intenzione di non usare il filo di alimentazione per un lungo periodo di tempo. • Desconecte el cordón de energía cuando no utilice el equipo por mucho tiempo. • Neem altijd het netsnoer uit het stopcontact wanneer het apparaat gedurende een lange periode niet wordt gebruikt. • Koppla ur nätkabeln om apparaten inte kommer att användas i lång tid. 	 <ul style="list-style-type: none"> • Do not let insecticides, benzene, and thinner come in contact with the set. • Lassen Sie das Gerät nicht mit Insektiziden, Benzin oder Verdünnungsmitteln in Berührung kommen. • Ne pas mettre en contact des insecticides, du benzène et un diluant avec l'appareil. • Assicuratevi che l'unità non venga in contatto con insetticidi, benzolo o solventi. • No permita el contacto de insecticidas, gasolina y diluyentes con el equipo. • Laat geen insektenverdelgende middelen, benzine of ververdunner met dit apparaat in contact komen. • Se till att inte insektsmedel på spraybruk, bensin och thinner kommer i kontakt med apparatens hölje.
<ul style="list-style-type: none"> • Please be care the environmental aspects of battery disposal. • The apparatus shall not be exposed to dripping or splashing for use. • No objects filled with liquids, such as vases, shall be placed on the apparatus. 	 <p>* (For sets with ventilation holes)</p> <ul style="list-style-type: none"> • Do not obstruct the ventilation holes. • Die Belüftungsoffnungen dürfen nicht verdeckt werden. • Ne pas obstruer les trous d'aération. • Non coprite i fori di ventilazione. • No obstruya los orificios de ventilación. • De ventilatieopeningen mogen niet worden blokkeerd. • Tapp inte till ventilationsöppningarna. 	 <ul style="list-style-type: none"> • Never disassemble or modify the set in any way. • Versuchen Sie niemals das Gerät auseinander zu nehmen oder auf jegliche Art zu verändern. • Ne jamais démonter ou modifier l'appareil d'une manière ou d'une autre. • Non smontate mai, nè modificate l'unità in nessun modo. • Nunca desarme o modifique el equipo de ninguna manera. • Nooit dit apparaat demonteren of op andere wijze modifieren. • Ta inte isar apparaten och försök inte bygga om den.

CAUTION

- The ventilation should not be impeded by covering the ventilation openings with items, such as newspapers, table-cloths, curtains, etc.
- No naked flame sources, such as lighted candles, should be placed on the apparatus.

• DECLARATION OF CONFORMITY

We declare under our sole responsibility that this product, to which this declaration relates, is in conformity with the following standards: EN60065, EN55013, EN55020, EN61000-3-2 and EN61000-3-3. Following the provisions of 73/23/EEC, 89/336/EEC and 93/68/EEC Directive.

• ÜBEREINSTIMMUNGSEKTLÄRUNG

Wir erklären unter unserer Verantwortung, daß dieses Produkt, auf das sich diese Erklärung bezieht, den folgenden Standards entspricht: EN60065, EN55013, EN55020, EN61000-3-2 und EN61000-3-3. Entspricht den Verordnungen der Direktive 73/23/EEC, 89/336/EEC und 93/68/EEC.

• DECLARATION DE CONFORMITE

Nous déclarons sous notre seule responsabilité que l'appareil, auquel se réfère cette déclaration, est conforme aux standards suivants: EN60065, EN55013, EN55020, EN61000-3-2 et EN61000-3-3. D'après les dispositions de la Directive 73/23/EEC, 89/336/EEC et 93/68/EEC.

• DICHIARAZIONE DI CONFORMITÀ

Dichiariamo con piena responsabilità che questo prodotto, al quale la nostra dichiarazione si riferisce, è conforme alle seguenti normative: EN60065, EN55013, EN55020, EN61000-3-2 e EN61000-3-3. In conformità con le condizioni delle direttive 73/23/EEC, 89/336/EEC e 93/68/EEC. QUESTO PRODOTTO E' CONFORME AL D.M. 28/08/95 N. 548

• DECLARACIÓN DE CONFORMIDAD

Declaramos bajo nuestra exclusiva responsabilidad que este producto al que hace referencia esta declaración, está conforme con los siguientes estándares: EN60065, EN55013, EN55020, EN61000-3-2 y EN61000-3-3. Siguiendo las provisiones de las Directivas 73/23/EEC, 89/336/EEC y 93/68/EEC.

• EENVORMIGHEIDSVKLRING

Wij verklaren uitsluitend op onze verantwoordelijkheid dat dit produkt, waarop deze verklaring betrekking heeft, in overeenstemming is met de volgende normen: EN60065, EN55013, EN55020, EN61000-3-2 en EN61000-3-3. Volgens de bepalingen van de Richtlijnen 73/23/EEC, 89/336/EEC en 93/68/EEC.

• ÖVERENSSTÄMMELSEINTYG

Härmed intygas helt på eget ansvar att denna produkt, vilken detta intyg avser, uppfyller följande standarder: EN60065, EN55013, EN55020, EN61000-3-2 och EN61000-3-3. Enligt stadgarerna i direktiv 73/23/EEC, 89/336/EEC och 93/68/EEC.

FCC INFORMATION (For US customers)

1. PRODUCT

This product complies with Part 15 of the FCC Rules. Operation is subject to the following two conditions: (1) this product may not cause harmful interference, and (2) this product must accept any interference received, including interference that may cause undesired operation.

**2. IMPORTANT NOTICE:
DO NOT MODIFY THIS PRODUCT**

This product, when installed as indicated in the instructions contained in this manual, meets FCC requirements. Modification not expressly approved by DENON may void your authority, granted by the FCC, to use the product.

3. NOTE

This product has been tested and found to comply with the limits for a Class B digital device, pursuant to Part 15 of the FCC Rules. These limits are designed to provide reasonable protection against harmful interference in a residential installation. This product generates, uses and can radiate radio frequency energy and, if not installed and used in accordance with the instructions, may cause harmful interference to radio communications. However, there is no guarantee that interference will not occur in a particular installation. If this product does cause harmful interference to radio or television reception, which can be determined by turning the product OFF and ON, the user is encouraged to try to correct the interference by one or more of the following measures:

- Reorient or relocate the receiving antenna.
- Increase the separation between the equipment and receiver.
- Connect the product into an outlet on a circuit different from that to which the receiver is connected.
- Consult the local retailer authorized to distribute this type of product or an experienced radio/TV technician for help.

■ INTRODUCTION

Thank you very much for purchasing the DENON DN-X100 DJ MIXER. DENON proudly presents this advanced DJ MIXER to audiophiles and music lovers as a further proof of DENON's non-compromising pursuit of the ultimate in sound quality. The high quality performance and easy operation are certain to provide you with many hours of outstanding listening pleasure.

– TABLE OF CONTENTS –

1 MAIN FEATURES5	4 SPECIFICATIONS.....8
2 PART NAMES AND FUNCTIONS5, 6	5 FADER START9
3 CONNECTIONS7	6 ROTATING INPUT SELECT SWITCHES10

■ ACCESSORIES

Please check to make sure the following items are included with the main unit in the carton:

- | |
|---|
| ① Operating instructions.....1 |
| ② AC adaptor1
(AA-26 : for AC 120 V, AA-27 : for AC 230 V) |

1 MAIN FEATURES

- 1. 2-Channel DJ Mixer**
4 LINE, 2 PHONO, 1 Microphone systems and 2 MASTER outputs are provided independently.
- 2. VCA controlled Channel Fader and Crossfader**
- 3. Channel Fader and Crossfader contour adjustable**
This feature allows adjusting the "shape" of the Crossfader and Channel fader response from a gentle curve for smooth to the steep pitch required for top performance cut and scratch effects.
- 4. Channel Fader and Crossfader Reverse**
- 5. Channel Fader and Crossfader Start**
The CD player can be started or stopped simply by increasing or decreasing the level of the Ch.fader or by using the Crossfader left to right or right to left. (This function can only be used when the DENON CD players DN-S3000, DN-S5000, DN-S1000 or etc. is connected to the DN-X100.)
- 6. Channel Reverse function**
This function allows the left hand channel fader or right hand channel fader to control PGM1 or PGM2.
- 7. 3-Band Equalizer/Gain**
LOW, MID, HI and GAIN controls are available on every input channel.
- 8. 4 direction placement for input selector**
- 9. Microphone Talkover function**

2 PART NAMES AND FUNCTIONS (Refer to page 3.)

(1) Top panel

- 1 MIC ON/OFF/TALKOVER switch**
 - When TALKOVER is selected, all signals except the microphone level are decreased by 20 dB. When at the ON or OFF position all signals remain at their standard levels.
- 2 MIC EQ controls**
 - Contour the frequency response of the Mic input -12 dB to +12 dB.
 - At the center position, sound is flat.
- 3 MIC LEVEL control**
 - Adjust the level of Mic signal.
- 4 Source EQ controls**
 - Contour the frequency response of the selected inputs.
 - HI and MID:**
 - Adjusts the high-tone and mid-tone sound -40 dB to +10 dB.
 - LOW:**
 - Adjusts the high-tone and mid-tone sound -40 dB to +6 dB.
 - NOTE:**
Clipping may occur if adjustments are set to harsh.
- 5 Input select switch**
 - Switches between the PHONO/LINE and LINE inputs.
 - When the lever of switch is vertical position, the LINE2 or LINE4 input is selected.
 - When the lever of switch is slope, the PHONO1/LINE1 or PHONO2/LINE3 input is selected.
 - You can perform 4 direction placement. See page 10.
- 6 CUE buttons**
 - These buttons are used to activates a channels "CUE" mode, the LED above the cue button will glow when cue mode is activated. Cue mode will send a channels incoming signal to the headphones.
- 7 GAIN**
 - Adjusts the gain of each input channel.
- 8 MASTER LEVEL control**
 - Adjust the level of the MASTER output.
- 9 MASTER BALANCE control**
 - Adjust the L/R balance of the MASTER outputs.
- 10 Headphone PAN control**
 - This function allows you to monitor the CUE level as well as the MASTER output in your headphones. A CUE Level may only be monitored of the CUE signal is selected.
 - Serves two purposes...In the STEREO mode it changes the relative levels of the CUE and MASTER mixed together in both ear cups. In the SPLIT CUE mode it changes the balance between the monaural CUE sound in the left and monaural MASTER sound in the right.
- 11 PHONES LEVEL control**
 - Adjusts the headphone output level.
- 12 SPLIT CUE button**
 - In the STEREO mode, the stereo sound of MASTER and CUE are fed to both ear cups. In the SPLIT CUE mode, the headphone circuit provides monaural CUE sound to the left and monaural MASTER sound to the right.
 - When the Level Meter mode select switch is set to "MASTER"...In the STEREO mode, the meter indicates the stereo level in the L/R Master output. In the SPLIT CUE mode, the monaural CUE sound level is displayed on the left and the monaural MASTER sound level is displayed on the right.
 - In the SPRIT CUE mode, the LED is lit.
- 13 Channel Fader**
 - Controls the channel output level.

14 Crossfader

- Fades the overall mixer output between channels 1 and 2.

15 Level Meter

- The dual LED's indicators are used to detail either the master output level, a combination of the master output level and the CUE signal level, or the PGM1/2 monaural level.

16 CH REVERSE button

- This switch allows the left hand fader or right hand fader to control PGM1 or PGM2.
- When the CH REVERSE mode is ON, the CH1 fader will be able to control PGM 2 sound and the CH2 fader will be able to control PGM 1 sound..

NOTE:

- Please don't confuse with the CH 1/2 FADER REVERSE switch (22).

17 Level meter mode select switch

- The position of this switch will determine the Level Meter mode. In the "MASTER" position, the meter will detail the out level of the left and right channels. In the "PGM 1/2" position, the left side of the meter will indicate monaural level of the PGM 1 and the right side of the meter will indicate monaural level of the PGM 2.

(2) Rear panel**18 Power operation switch (POWER)**

- Selects power "ON" or "OFF".

NOTE:

Whenever the power switch is in the OFF state, the AC adaptor is still connected on AC line voltage. Please be sure to unplug the cord when you don't use for along time.

19 Balanced MASTER OUT jacks (BAL.)

- These 1/4" TRS jacks provide a balanced line level output.
- Connect these jacks to the balanced analog input jacks on an amplifier or console.
- Pin layout: Tip=Hot Ring=Cold Sleeve=GND

20 MIC BALANCED INPUT jack

- Accepts an balanced microphone with 1/4" TRS mono jacks.
- Pin layout: Tip=Hot Ring=Cold Sleeve=GND

21 PGM1, 2 FADER output jacks

- Connect these jacks to the FADER input jacks of DN-S3000, DN-S5000, DN-S1000 and etc. using the 3.5mm stereo mini cord.

22 Phono ground screw (GND)

- This screws provide a place to connect the ground wire from a turntable.
- This terminal is exclusively for a turntable ground and not a safety earth ground.

23 PHONO1, 2 / LINE1, 3 switches (LN / PH)

- These switches change the input from PHONO to a LINE level input.
- These switches set a LINE level input when turntable is not connected.

NOTE:

Always be sure main power is shut off before change the position of the Line Level Selector Switch.

24 PHONO1, 2 / LINE1, 3 input jacks

- These stereo pair of unbalanced RCA jacks are inputs for a PHONO (RIAA) stage for magnetic (MM) cartridges or a LINE stage suitable for any device, such as a CD player.

25 LINE2, 4 input jacks

- These stereo pair of unbalanced RCA jacks are inputs for any line level device.

26 Unbalanced MASTER OUT jacks

- This stereo pair of RCA jacks provides an unbalanced line level output.
- Connect these jacks to the unbalanced analog input jacks on an amplifier or console.

27 AC IN

- Input connection for the included AC adaptor.

NOTE:

Use specified attached AC adaptor only.

(3) Front panel**28 CH 1/2 FADER START switches**

- Use this to switch the Channel Fader Start function ON and OFF.

29 CROSSFADER START A/B switches

- Use this to switch the Crossfader Start function ON and OFF.

30 HEADPHONE output jack

- Accept 1/4" stereo headphone plugs.

31 CH 1/2 FADER CONTOUR adjustment

- Adjusts the curve of the CH1/2 faders between fast, normal, or slow fade.

32 CH 1/2 FADER REVERSE switch

- Reverses the direction of each respective input CH1/2 fader.

33 CROSSFADER CONTOUR adjustment

- Adjusts the shape of the crossfader curve from a fast cut for scratching or to a slow fade for mixing.

34 CROSSFADER REVERSE switch

- Reverses the direction of the crossfader.

3 CONNECTIONS

Refer to the connection diagram below.

1. Make certain AC power is off while making connections.
2. Quality cables make a big difference in fidelity and punch. Use high-quality, audio cables.
3. Do not use excessively long cables. Be sure plugs and jacks are securely fastened. Loose connections cause hum, noise, or intermittents that could damage your speakers.
4. Connect all stereo input sources. Then connect any effects into the stereo effect, if used. Connect your microphone(s) and monitor headphones. Make sure all faders are at "zero" and the unit is off. Take care to connect only one cable at a time. Pay attention to L and R position of jacks, on both the DN-X100 and outboard gear.
5. Connect the stereo outputs to the power amplifier(s) and/or tape deck(s) and/or MD recorder(s) and/or CD recorder(s). Plug the DN-X100 into AC power outlet.

NOTE:
Always switch on your audio input sources such as CD players first, then your mixer, and finally any amplifiers. When turning off, always reverse this operation by turning off amplifiers, then your mixer, and then input units.

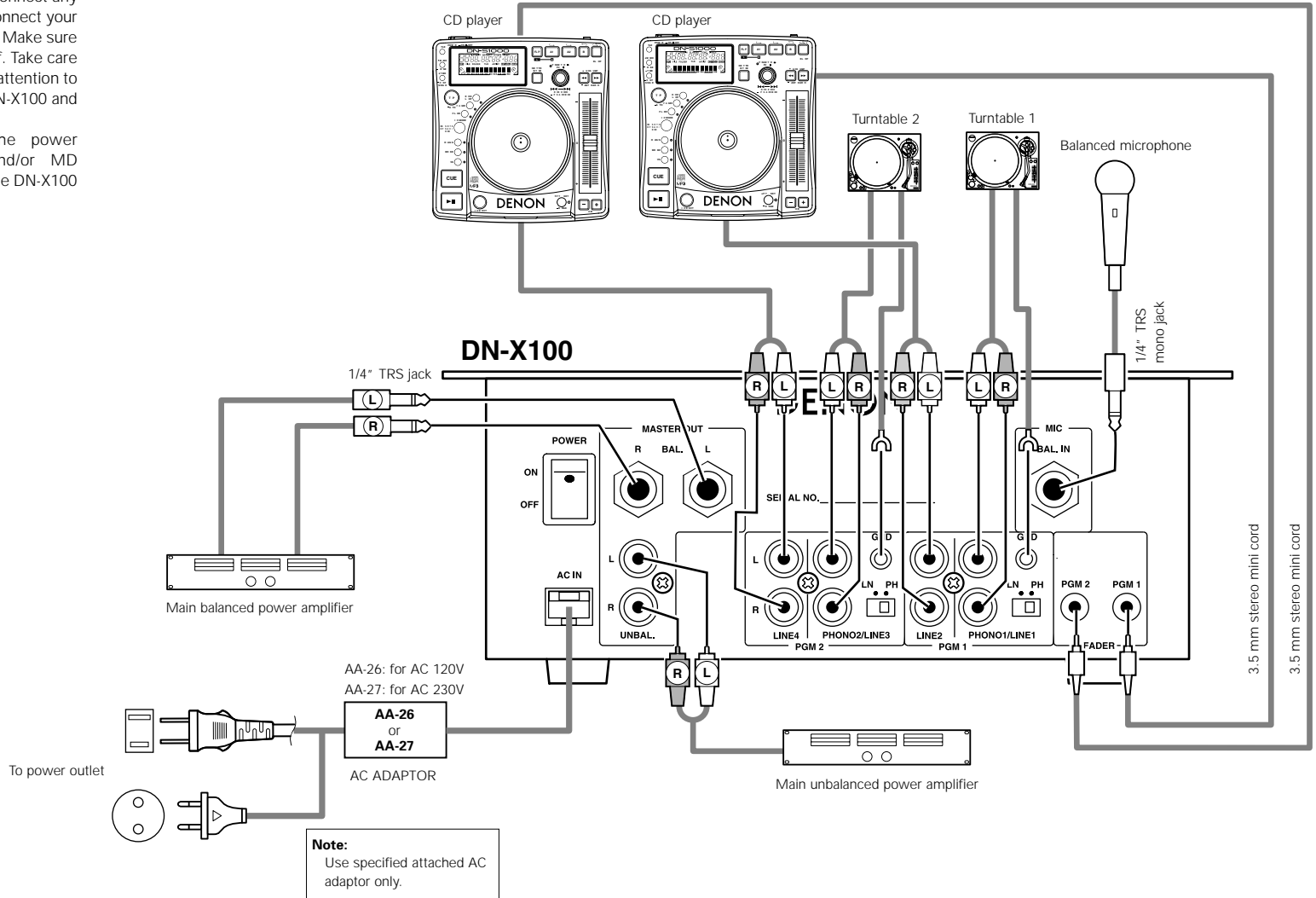

Note:
Use specified attached AC adaptor only.

4 SPECIFICATIONS

- **Phono Inputs:** 2 Stereo Unbalanced RCA jacks
Input Impedance 50 k Ω /kohms
Level -50 dBV (3 mV)
- **Line Inputs:** 2 Stereo Unbalanced RCA jacks
Input Impedance 20 k Ω /kohms
Level -14 dBV (200 mV)
- **EQ Control (Line):** 3 Bands
Control Range
 HI: -30 dB to +10 dB (at 16 kHz), -38 dB to +10 dB (at 20 kHz)
 MID: -38 dB to +10 dB (at 1 kHz)
 LOW: -38 dB to + 6 dB (at 60 Hz)
- **Mic Inputs:** 1 Mono Active Balanced 1/4" TRS jack
Input Impedance 2 k Ω /kohms
Level -54 dBV (2 mV)
Frequency Response 20 Hz to 20 kHz (\pm 3 dB)
S/N 66dB
- **EQ Control (Mic):** 2 Bands
Control Range
 HI: -12 to +12 dB (at 10 kHz)
 LOW: -12 to +12 dB (at 100 Hz)
- **Master Output:**
Balanced Stereo Active Balanced 1/4" TRS jack
Output Impedance 150 Ω /ohms
Level +4 dBm (1.23 Vrms) (600 Ω /ohms load)
Frequency Response 20 Hz to 20 kHz (\pm 2 dB)
THD+N LINE : Below 0.05 % PHONO : Below 0.07 %
S/N LINE : 85 dB PHONO : 76 dB
Cross Talk Over 75 dB
Unbalanced Stereo Unbalanced RCA jacks
Output Impedance 1 k Ω /kohms
Level 0 dBV (1 Vrms)V (10 k Ω /ohms load)
Frequency Response 20 Hz to 20 kHz (\pm 2 dB)
THD+N LINE : Below 0.05 % PHONO : Below 0.07 %
S/N LINE : 85 dB PHONO : 76 dB
Cross Talk Over 75 dB
- **Headphone Output:** Stereo
Output Impedance 33 Ω /ohms
Level 0 dBV (1 Vrms) (32 Ω /ohms load)
- **Power Source:** AC 10 V 750 mA x 2
- **Power Supply, Consumptions:**
USA, Canada AC 120 V \pm 10 %, 60 Hz (AC adaptor : AA-26)
Europe, Asia, Oceania AC 230 V \pm 10 %, 50 Hz (AC adaptor : AA-27)
- **Unit Size** 220 (W) x 226 (D) x 85.4 (H) mm
- **Mass** 2.8 kg AC adaptor : 0.5 kg

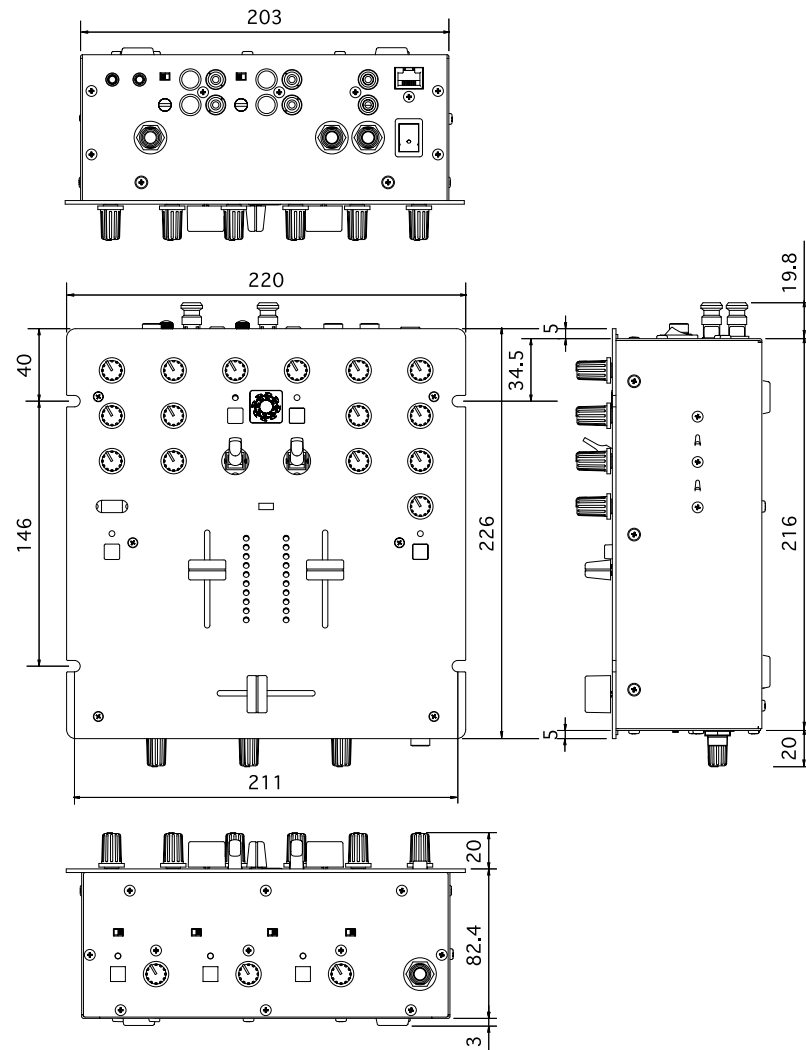

* Specifications and design are subject to change without notice for purpose of improvement.

5 FADER START

If the separately sold DN-S5000, DN-S3000, DN-S1000 and etc. players are connected to FADER PGM1 or PGM2, they can be started using the Channel fader or Crossfader, as long as the 3.5 mm stereo mini cords have been connected.

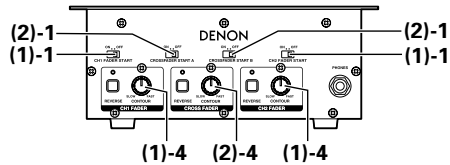
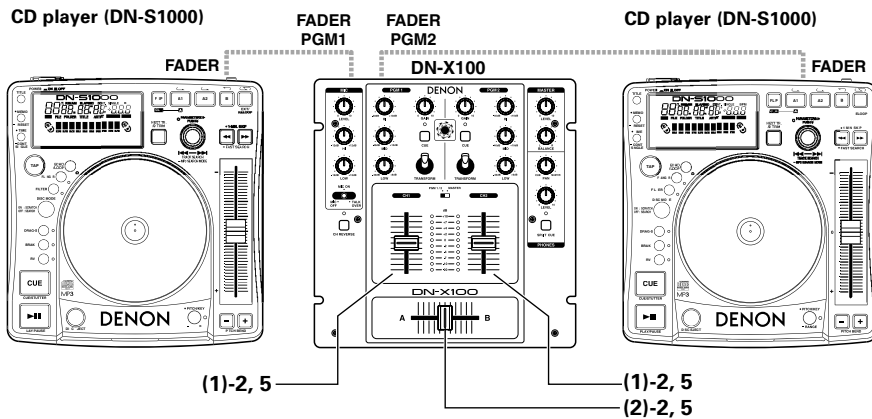
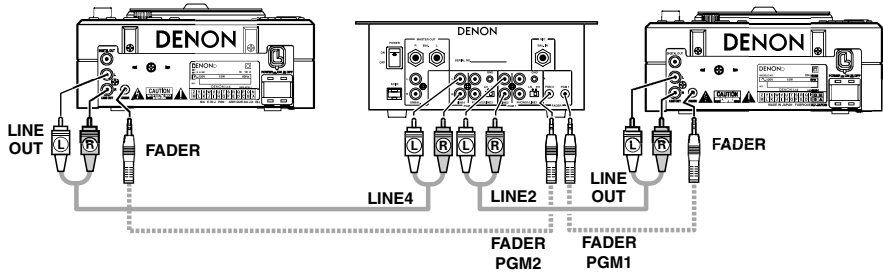

Channel Fader Start

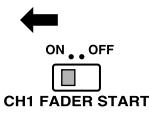
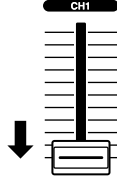
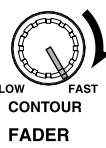
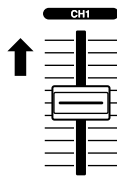
- Turn on the CH 1/2 FADER START switches ②. 
- Move the Channel fader ⑬ of CH-1 or CH-2 control all the way to the bottom. 
- Set the standby mode on CD player.
- Use the CH 1/2 FADER CONTOUR controls ⑨ to control the Channel fader startup curve. 
- When you want to start the player, move up the Channel fader ⑬ and the CD player will begin playing. 

NOTE:

- When the CH 1/2 FADER REVERSE switch is set to ON, the corresponding fader's operating direction is reversed.

Crossfader Start

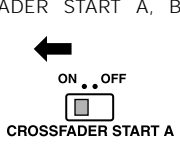
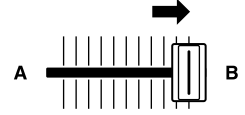
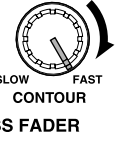
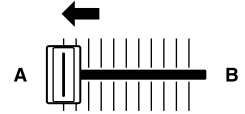
- Turn on the CROSSFADER START A, B switches ②. 
- Slide the Crossfader ⑭ all the way in direction opposite the source you want to start. (In the following example, startup is done with the CD player connected to PGM1.) 
- Set the standby mode on CD player.
- Use the CROSS FADER CONTOUR control ⑩ to control the Crossfader startup curve. 
- When the Crossfader ⑭ is slid in the opposite direction, CD player play will begin. 

NOTES:

- When the CROSS FADER REVERSE switch is set to ON, the Crossfader's operating direction is reversed.
- Channel Fader Start and Crossfader Start for the same source will not operate simultaneously. You must select from either one. If both CH FADER START and CROSSFADER START A, B switches are ON, priority will be the Crossfader.

6 ROTATING INPUT SELECT SWITCHES

1. Disconnect the power.
2. Remove knobs from the Top Panel.
3. Remove the 6 screws attaching the Top Panel.
4. Remove the 2 screws attaching the Switch unit.
5. Rotate the Switch unit to the desired location.
6. Reinstall the 2 screws holding the Switch unit.
7. Reinstall the Top Panel and reattach knobs.

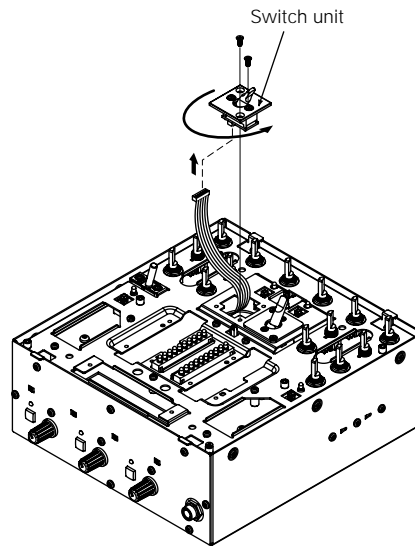
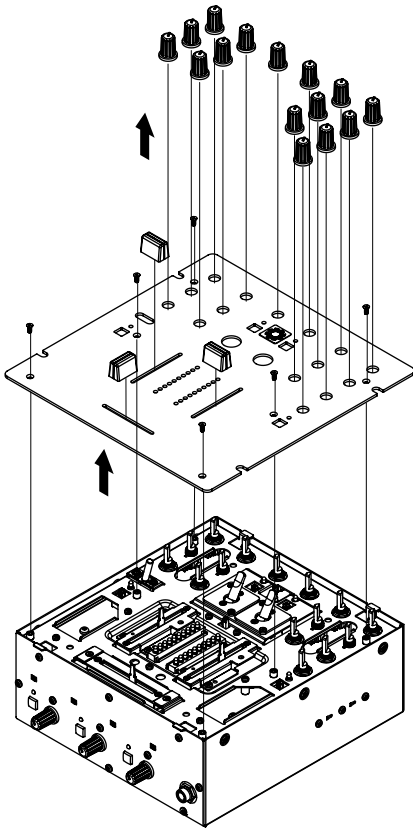

About the Cables

(For RCA PINJACK)

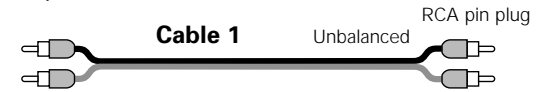

(For BALANCED MASTER OUT)

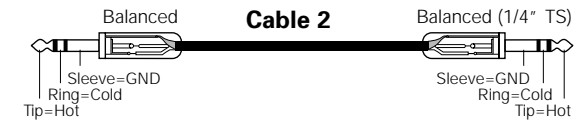

(For MIC)

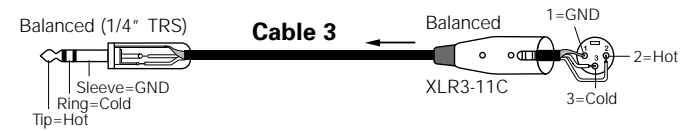

(For BALANCED MASTER OUT)

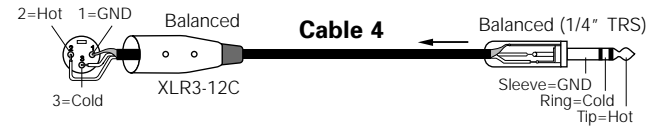

■ INTRODUCCIÓN

Gracias por haber adquirido el reproductor de DENON DN-X100 DJ MIXER.

DENON se siente orgulloso de presentar este avanzado DJ MIXER para los aficionados y amantes de la música como una prueba más de la búsqueda sin obligaciones de DENON de lo último en calidad de sonido. El rendimiento de alta calidad y la fácil operación sin duda le proporcionarán muchas horas de deleite con una escucha excepcional.

– CONTENIDO –

1	FUNCIONES PRINCIPALES.....	29	5	FADER START	33
2	NOMBRES Y FUNCIONES DE PARTES.....	29, 30	6	INTERRUPTORES SELECTORES GIRATORIOS DE LAS ENTRADAS.....	34
3	CONEXIONES.....	31			
4	ESPECIFICACIONES	32			

■ ACCESSORIOS

Compruebe que los siguientes elementos se encuentran en la caja junto con la unidad principal:

①	Instrucciones de operación.....	1
②	Adaptador de CA.....	1
	(AA-26 : para CA 120 V, AA-27 : para CA 230 V)	

1 FUNCIONES PRINCIPALES

1. DJ Mixer bicanal

Se suministran 4 LÍNEAS, 2 PHONO, 1 sistema de micrófono y 2 salidas MASTER independientes.

2. Crossfader (dispositivo de atenuación cruzada) y atenuador de canal controlados mediante un atenuador controlado por voltaje

3. Curva ajustable del crossfader y el atenuador de canal

Esta característica permite ajustar la "forma" de la respuesta del crossfader y el atenuador de canal desde una curva suave para conseguir deslizamientos largos, hasta el tono abrupto necesario para efectos de cortes de actuaciones de alta calidad y efectos de rayado.

4. Función de inversión del crossfader y el atenuador de canal

5. Comienzo de Fader y Comienzo de Crossfader

El reproductor de CD puede ponerse en marcha y detenerse simplemente aumentando o disminuyendo el nivel del fader de Ch. o con el fader de cruce de izquierda a derecha a o de derecha a izquierda. (Esta función sólo puede utilizarse cuando los reproductores de CD de DENON DN-S3000, DN-S5000, DN-S1000 u otros están conectados a la unidad DN-X100.)

6. Función de inversión de canal

Esta función permite al atenuador de canal izquierdo o derecho controlar el PGM1 o el PGM2.

7. Ecualizador/Ganancia de 3 bandas

Los controles LOW, MID, HI y GAIN están disponibles para todos los canales de entrada.

8. Posición en 4 direcciones para el selector de entrada

9. Función de micrófono Talkover

2 NOMBRES Y FUNCIONES DE PARTES (Fate riferimento alla pagina 3.)

(1) Panel superior

1 Interruptor MIC ON/OFF/TALKOVER

- Cuando la opción TALKOVER está seleccionada, todas las señales, excepto el nivel del micrófono, disminuirán 20 dB. Cuando está en la posición ON u OFF, todas las señales permanecerán en los niveles estándar.

2 Controles de MIC EQ

- Modela la respuesta de frecuencia de la entrada de Micrófono Principal de -12 dB a +12 dB.
- En la posición central el sonido será plano.

3 Controle de MIC LEVEL

- Ajusta el nivel de la señal Mic.

4 Controles de EQ de la fuente

- Modela la respuesta de frecuencia de las entradas seleccionadas.

HI y MID:

- Ajuste el sonido de tono alto y de tono medio entre -40 dB y +10 dB.

LOW:

- Ajusta el sonido de registros graves de -40 dB a +6 dB.

NOTA:

- Si el ajuste se realiza a muy agudo puede producirse saturación.

5 Interruptor selector de entrada

- Alterna entre las entradas PHONO/LINE y LINE.
- Cuando la palanca del interruptor está en posición vertical, estará seleccionada la entrada LINE2 o LINE4.
- Cuando la palanca del interruptor esté inclinada, estará seleccionada la entrada PHONO1/LINE1 o PHONO2/LINE3.
- Puede colocar la palanca en 4 posiciones. Consulte la página 34.

6 Botones CUE

- Estos botones sirven para activar el modo de canales "CUE". El testigo encima del botón "CUE" se iluminará cuando se active el modo CUE. El modo CUE enviará una señal de entrada de los canales a los auriculares.

7 GAIN

- Ajusta la ganancia de cada canal de entrada.

8 Controle de MASTER LEVEL

- Ajusta el nivel de las salidas MASTER.

9 Controle de MASTER BALANCE

- Ajuste el balance L/R de las salidas MASTER.

10 Controle de Headphone PAN

- Esta función le permite controlar el nivel de CUE y la salida MASTER de sus auriculares. Sólo podrá controlar un nivel de CUE si la señal CUE está seleccionada.
- Tiene dos funciones: En el modo STEREO, cambia los niveles relativos de CUE y MASTER mezclados en ambos auriculares. En el modo SPLIT CUE, cambia el balance entre el sonido monoaural CUE en el auricular izquierdo y el sonido monoaural MASTER en el derecho.

11 Controle de PHONES LEVEL

- Ajusta el nivel de salida de los auriculares.

12 Botón SPLIT CUE

- En el modo STEREO, el sonido estéreo de MASTER y CUE se enviará a ambos auriculares. En el modo SPLIT CUE, el circuito del auricular suministrará sonido monoaural CUE al lado izquierdo y sonido monoaural MASTER al derecho.
- Cuando el interruptor selector del modo del medidor de nivel está en la posición MASTER en el modo STEREO, el medidor indicará el nivel estéreo en la salida principal izquierda y derecha. En el modo SPLIT CUE, el nivel de sonido monoaural CUE se mostrará en el lado izquierdo y el nivel de sonido monoaural MASTER se mostrará en el lado derecho.
- En el modo SPLIT CUE, el DEL se iluminará.

13 Canal Fader

- Controla el nivel de salida de los canales.

14 Crossfader

- Atenua la salida del mezclador general entre los canales 1 y 2.

15 Medidor de nivel

- Los indicadores DEL duales se utilizan para detallar el nivel de salida principal, una combinación del nivel de salida principal y el nivel de la señal CUE, o el nivel monoaural de PGM1/2.

16 Botón CH REVERSE

- Esta interruptor permite al atenuador izquierdo o derecho controlar el PGM1 o el PGM2.
- Cuando el modo CH REVERSE (inversión de canal) está en la posición ON, el atenuador del canal 1 (CH1) podrá controlar el sonido del PGM 2, y el atenuador del canal 2 (CH2) podrá controlar el sonido del PGM 1.

NOTA:

No debe confundirse con el interruptor 22 de la función FADER REVERSE (inversión del atenuador) de los canales 1 y 2.

17 Interruptor selector del modo del medidor de nivel

- La posición de este interruptor determinará el modo del medidor de nivel. En la posición "MASTER", el medidor detallará el nivel de salida de los canales izquierdo o derecho. En la posición "PGM 1/2", el lado izquierdo del medidor indicará el nivel monoaural del PGM 1 y el lado derecho, indicará el nivel monoaural del PGM 2.

(2) Panel posterior

18 Interruptor de funcionamiento de alimentación (POWER)

- Coloca la unidad en "ON" o en "OFF".

NOTA:

Siempre que el interruptor de alimentación esté en posición OFF, el adaptador de CA seguirá estando conectado al voltaje de línea de CA. Asegúrese de desenchufar el cable cuando no deba utilizar la unidad durante un periodo de tiempo prolongado.

19 Terminales BALANCED MASTER OUT

- Los conectores TRS de 1/4" pulgadas proporcionan una salida de nivel equilibrado.
- Conecte estos conectores a los enchufes de entrada analógica equilibrada de un amplificador o consola.
- Disposición de los contactos:
Punta=Caliente Anillo=Fría Funda=GND

20 Terminale MIC BALANCED INPUT

- Acepta un micrófono equilibrado con conexiones modo TRS de 1/4".
- Disposición de los contactos:
Punta=Caliente Anillo=Fría Funda=GND

21 Terminales de salida PGM1, 2 FADER

- Conecte estas clavijas a las tomas de entrada FADER de las unidades DN-S3000, DN-S5000, DN-S1000, etc., utilizando un minicable estéreo de 3,5 mm.

22 Tornillo de Toma a Tierra de Fono (GND)

- Estos tornillos permiten la conexión de un cable de masa al plato.
- Este terminal es exclusivo para la masa de un plato y no para una conexión a tierra de seguridad.

23 Interruptores PHONO1, 2 / LINE1, 3 (LN / PH)

- Estos interruptores cambian la Entrada de Fono a una entrada de nivel de Línea.
- Estos interruptores ajustan las entradas de nivel de línea cuando un tocadiscos no está conectado.

NOTA:

Siempre debe comprobar que la unidad está apagada antes de cambiar la posición del interruptor selector del nivel de línea.

24 Terminales de entrada PHONO1, 2 / LINE1, 3

- Estos pares de terminales RCA no balanceados son entradas para una etapa Fono (RIAA) cápsulas (MM) magnéticas o una etapa de Línea adecuada para cualquier dispositivo, como un reproductor de CD.

25 Terminales de entrada LINE2, 4

- Estos pares de terminales RCA estéreo no balanceados son entradas para cualquier dispositivo de nivel de línea.

26 Terminales UNBALANCED MASTER OUT

- Este par de terminales RCA estéreo proporciona una salida de nivel de línea no balanceada.
- Conecte estos terminales a los conectores de entrada analógica no balanceada de un amplificador o mesa de mezclas.

27 AC IN (Entrada de alimentación)

- Conexión de entrada para el adaptador de CA incluido.

NOTA:

Utilice únicamente el adaptador de CA acoplado especificado.

(3) Panel delantero

28 Interruptores CH 1/2 FADER START

- Utilice esta función para cambiar entre ON y OFF en la función de inicio de atenuación de canal.

29 Interruptores CROSSFADER START A, B

- Utilice esta opción para cambiar entre ON y OFF en la función de inicio de crossfader.

30 Toma de salida HEADPHONE

- Acepta conectores de auriculares estéreo de 1/4".

31 Ajuste de CH 1/2 FADER CONTOUR

- Ajusta la curva de los atenuadores de los canales 1 y 2 entre atenuación rápida, normal o lenta.

32 Interruptor CH 1/2 FADER REVERSE

- Invierte la dirección de cada atenuador de entrada de los canales 1 y 2.

33 Ajuste de CROSSFADER CONTOUR

- Ajusta la forma de la curva del Crossfader desde un apagado rápido para rayados hasta una atenuación lenta para el mezclado.

34 Interruptor CROSSFADER REVERSE

- Invierte la dirección del crossfader.

3 CONEXIONES

Remítase al Diagrama de Conexión que figura a continuación.

1. Asegúrese de que la alimentación de c.a. está desactivada al realizar las conexiones.
2. Los cables de calidad implican una gran diferencia en cuanto a la fidelidad y a la pegada conseguidas. Utilice cables de audio de alta calidad.
3. No utilice cables excesivamente largos. Asegúrese de que los enchufes y los terminales queden firmemente sujetos. Las conexiones flojas provocan zumbidos, ruidos o intermitencias que podrían dañar los altavoces.
4. Conecte todas las fuentes de entrada estéreo. A continuación conecte la unidad de efectos en el Efecto estéreo, si se utiliza alguno. Conecte el micrófono(s) y los auriculares de monitorización. Asegúrese de que todos los mandos deslizantes se encuentran en la posición "cero" y de que la unidad está apagada. Procure conectar sólo un cable por vez. Preste atención a la posición R y L de los conectores, tanto en el DN-X100 como en el equipo externo.
5. Conecte las salidas estéreo al amplificador(es) y/o la platina(s) y/o el grabador(es) de MD y/o los grabadores de CD. Enchufe el DN-X100 en la toma de c.a. de la red eléctrica general.

NOTA:

Encienda siempre primero las fuentes de entrada de audio tales como reproductores CD, luego su mezclador, y finalmente cualquier amplificador. Cuando lo apague, siempre realice la operación inversa apagando los amplificadores, luego su mezclador y luego las unidades de entrada.

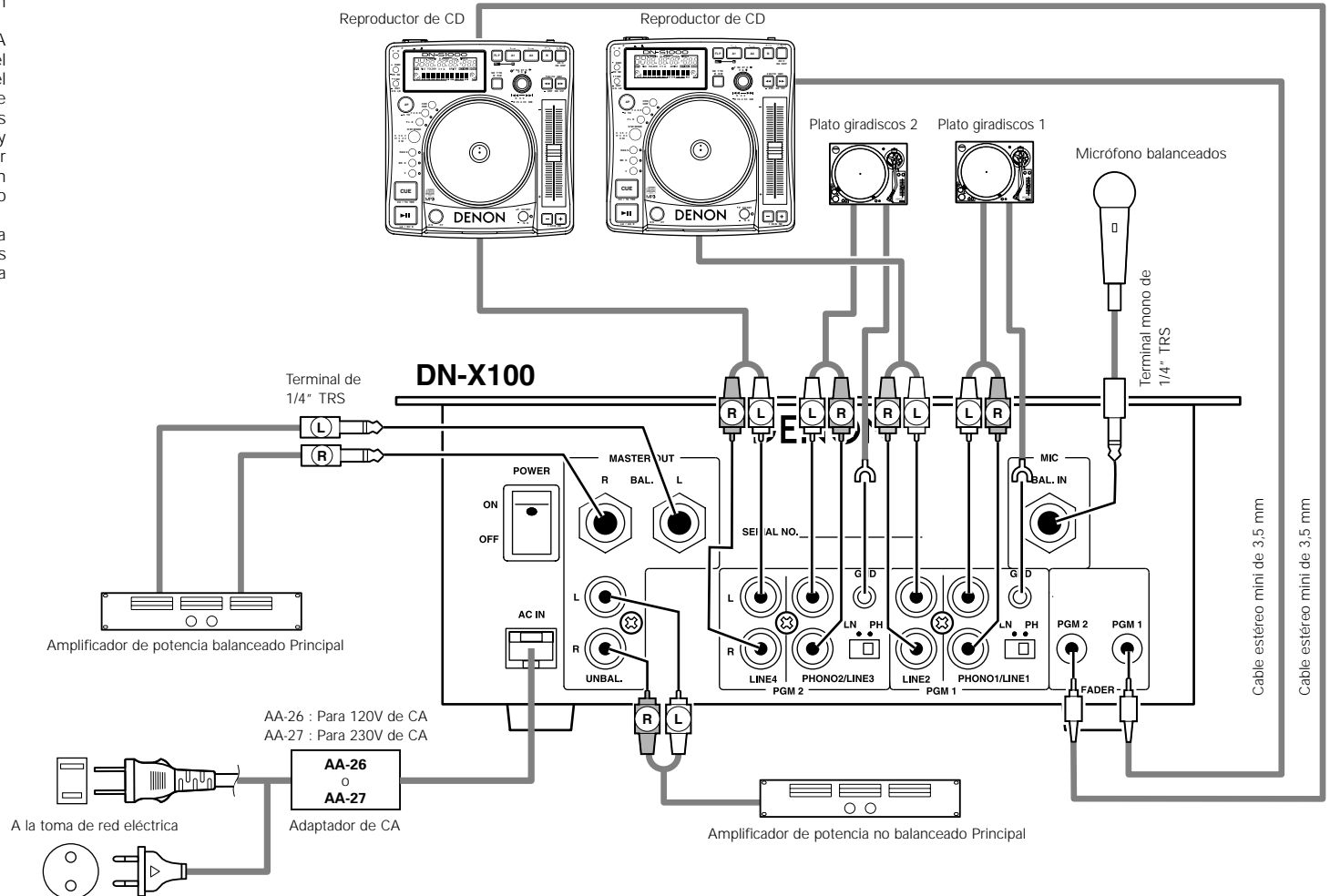

NOTA:
Utilice únicamente el adaptador de CA acoplado especificado.

4 ESPECIFICACIONES

- **Entradas Phono:** 2 entradas estéreo Conexiones RCA no equilibradas
Impedancia de entrada 50 k Ω /kohmios
Nivel -50 dBV (3 mV)
- **Entradas de línea:** 2 entradas estéreo Conexiones RCA no equilibradas
Impedancia de entrada 20 k Ω /kohmios
Nivel -14 dBV (200 mV)
- **Control de EQ (Línea):** 3 bandas
Intervalo de control HI : -30 dB hasta +10 dB (a 16 kHz), -38 dB hasta +10 dB (a 20 kHz)
MID : -38 dB hasta +10 dB (a 1 kHz)
LOW : -38 dB hasta + 6 dB (a 60 Hz)
- **Entradas Mic:** 1 entradas Mono Conexion 1/4" TRS equilibrio activo
Impedancia de entrada 2 k Ω /kohmios
Nivel -54 dBV (2 mV)
Respuesta de frecuencia 20 Hz a 20 kHz (\pm 3 dB)
S/N 66dB
- **Control de EQ (Mic):** 2 bandas
Intervalo de control HI : -12 hasta +12 dB (a 10 kHz)
LOW : -12 hasta +12 dB (a 100 Hz)
- **Salida Master:**
Equilibrada Entradas estéreo Conexion 1/4" TRS equilibrio activo
Impedancia de salida 150 Ω /ohmios
Nivel +4 dBm (1,23 Vrms) (Carga de 600 Ω /ohmios)
Respuesta de frecuencia 20 Hz a 20 kHz (\pm 2 dB)
THD+N LINE : Por debajo de 0,05 % PHONO : Por debajo de 0,07 %
S/N LINE : 85 dB PHONO : 76 dB
Diafonía Más de 75 dB
No equilibrada Entradas estéreo Conexiones RCA no equilibradas
Impedancia de salida 1 k Ω /kohmios
Nivel 0 dBV (1 Vrms) (Carga de 10 k Ω /kohmios)
Respuesta de frecuencia 20 Hz a 20 kHz (\pm 2 dB)
THD+N LINE : Por debajo de 0,05 % PHONO : Por debajo de 0,07 %
S/N LINE : 85 dB PHONO : 76 dB
Diafonía Más de 75 dB
- **Salida de auriculares:** Entradas estéreo
Impedancia de salida 33 Ω /ohmios
Nivel 0 dBV (1 Vrms) (Carga de 32 Ω /ohmios)
- **Fuente de alimentación:** CA 10 V 750 mA x 2
- **Fuente de alimentación, consumos:**
EE.UU. y Canadá CA 120 V \pm 10 %, 60 Hz (Adaptador de CA : AA-26)
Europa, Asia, Oceanía CA 230 V \pm 10 %, 50 Hz (Adaptador de CA : AA-27)
- **Tamaño de unidad** 220 (Anch) x 226 (Prof) x 85.4 (Alt) mm
- **Peso** Unidat : 2,8 kg Adaptador de CA : 0,5 kg

* Con el propósito de introducir mejoras, el diseño y las especificaciones del producto están sujetos a cambios sin previo aviso.

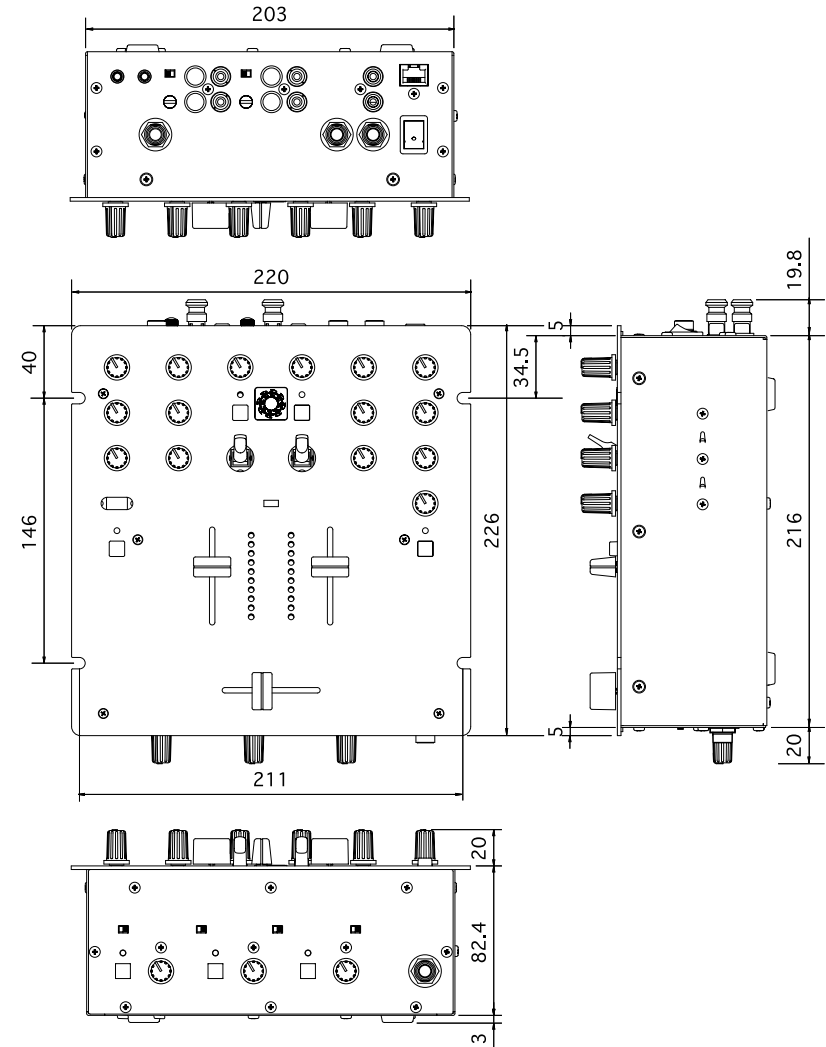





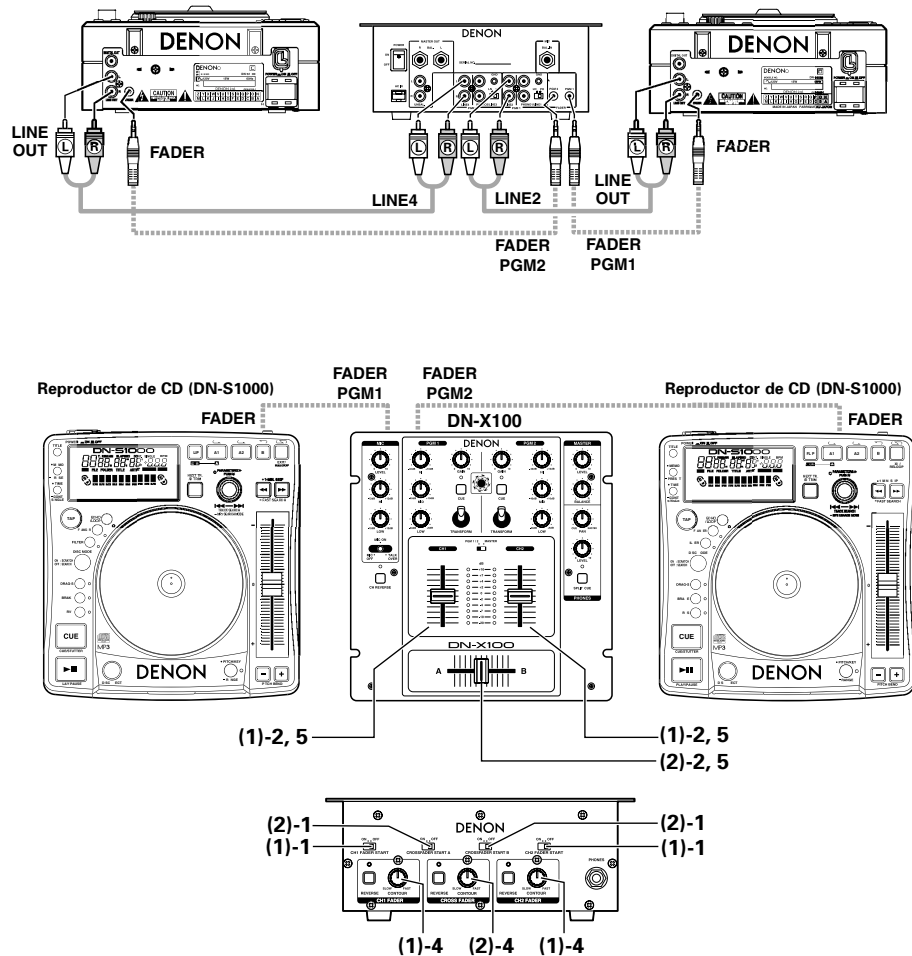

5 FADER START

Si los reproductores DN-S5000, DN-S3000, DN-S1000, etc., que se venden por separado, están conectados a la LÍNEA 1, 2, 3 ó 4, pueden encenderse mediante el atenuador de entrada de fuente (Atenuador de canal) o mediante el Crossfader, siempre y cuando se hayan conectado los minicables estéreo de 3,5 mm.



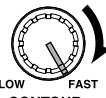
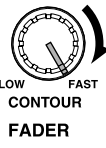

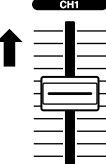

Comienzo de Fader de Canal

1	<p>Pulse los interruptores CH 1/2 FADER START .</p>  <p>CH1 FADER START</p>
2	<p>Desplace el atenuador de canal  del control del canal 1 o el canal 2 completamente hacia abajo.</p> 
3	<p>Establezca el modo Standby en el reproductor de CD.</p>
4	<p>Utilice los controles  de la función CH 1/2 FADER CONTOUR para controlar la curva de inicio del atenuador de canal.</p>  <p>CH1 FADER</p>
5	<p>Cuando desee iniciar el reproductor, suba el fader de entrada de fuente (fader de Ch.)  y el reproductor de CD comenzará a reproducir.</p> 

NOTA:

- Cuando el interruptor CH 1/2 FADER REVERSE está en posición ON, la dirección de funcionamiento del atenuador de canal se invertirá.

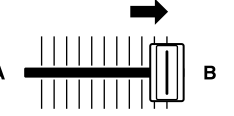
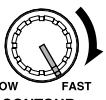
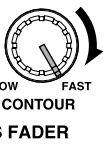
Comienzo de Crossfader

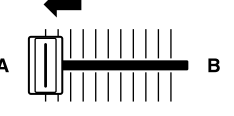
1	<p>Pulse los interruptores A y B de CROSSFADER START .</p>  <p>CROSSFADER START A</p>
2	<p>Deslice el Crossfader  a fondo en la dirección opuesta a la fuente que desee dar comienzo. (En el siguiente ejemplo, el inicio se realiza con el reproductor de CD conectado al PGM1.)</p> 
3	<p>Establezca el modo Standby en el reproductor de CD.</p>
4	<p>Use el control de CROSSFADER CONTOUR  para controlar la curva de comienzo de crossfader.</p>  <p>CROSS FADER</p>
5	<p>Cuando el Crossfade  se desliza en el sentido contrario, el reproductor de CD inicia su funcionamiento.</p> 

NOTAS:

- Cuando el interruptor CROSSFADER REVERSE está en posición ON, la dirección de funcionamiento del Crossfader se invertirá.
- El comienzo de Fader de Canal y el Comienzo de Fader de Cruce para la misma fuente no funcionarán simultáneamente. Deberá seleccionar uno de los dos. Si los interruptores CH FADER START y CROSSFADER START A, B están en la posición ON, la función que tendrá prioridad será el crossfader.

6 INTERRUPTORES SELECTORES GIRATORIOS DE LAS ENTRADAS

1. Desconecte la corriente.
2. Retire los botones del panel superior.
3. Retire los 6 tornillos que sujetan el panel superior.
4. Retire los 2 tornillos que sujetan la unidad del interruptor.
5. Haga girar la unidad del interruptor hasta la posición deseada.
6. Vuelva a montar los 2 tornillos que sujetan la unidad del interruptor.
7. Vuelva a instalar el panel superior y acople de nuevo los botones.

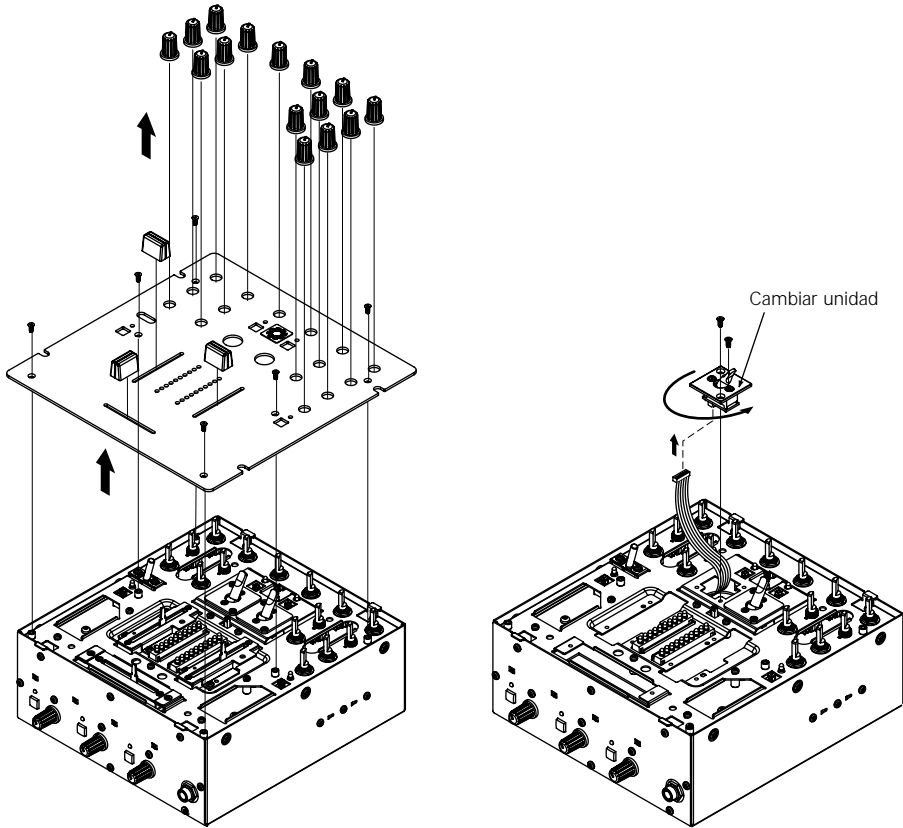

Acerca de los cables

(Para entrada RCA dentro/fuera)

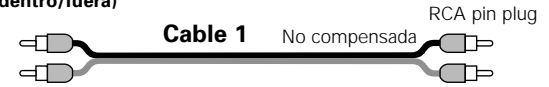

(Para BALANCED MASTER OUT)

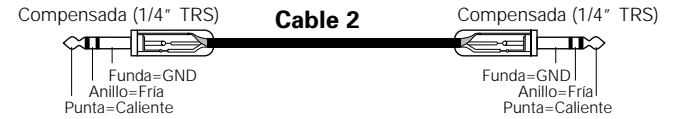

(Para MIC)



(Para BALANCED MASTER OUT)

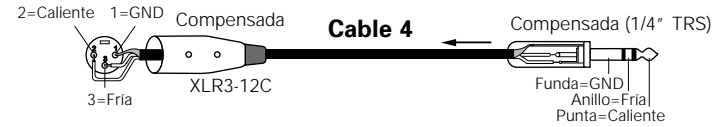

D&M Holdings Inc.
PROFESSIONAL BUSINESS COMPANY

7-35-1 Sagamiono, Sagamihara-shi, Kanagawa 228-8505, JAPAN